



modello:
model:

POWER LED

codice:
code:

0121

design:

UT Egoluce

anno - year:

2008

tipologia:

modulo Power LED

tipology:

power LED module

materiali:

dissipatore in alluminio, lente in metacrilato

materials:

aluminum heat sink, methacrylate lens

luce:

diretta

light:

direct

sorgente luminosa:

LED 3X3W 700mA 846lm 4000K

light source:

grado IP - IP grade:

20

peso netto - net weight:

0,03 Kg

marcatura:

CE

marking:

simboli costruttivi:

III \triangle 25°

symbols:

SOLO COLLEGAMENTO IN SERIE - ONLY SERIAL CONNECTION

Dimensioni - Dimensions

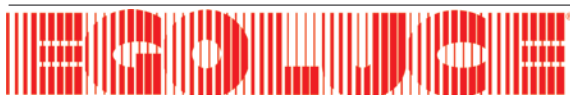
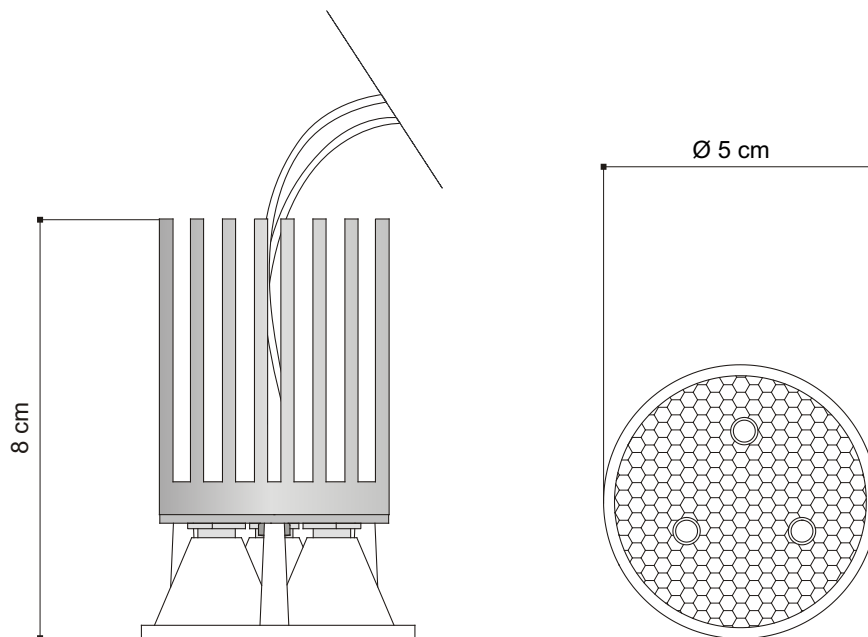



EGOLUCE s.r.l., via I. Newton 12 - 20016 Pero - Milano
telefono +39 02 339586.1 - fax. +39 02 3535112
e-mail: info@egoluce.com - <http://www.egoluce.com>

LED DRIVERS in corrente continua
LED DRIVERS constant current**0126**

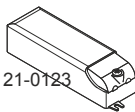
LED driver
IN: 110 - 240V
OUT: 700 mA
1-2 Power LED 3x3W - art. 0121-0123



11,2 x 3,9 x 2,8 cm  4,8 cm **SELV** **CLASS 2**  

0148/COB

LED driver
IN: 220 - 240V
OUT: 700 mA
1-3 Power LED - art. 0121-0123

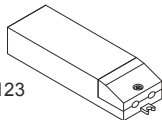

12,5 x 3,8 x 2,4 cm  4,2 cm **SELV** 

0169/50**Multipower LED driver**

IN: 220 - 240V
OUT: 700mA
min. 2 max 5 Power LED 3x3W - art. 0121-0123

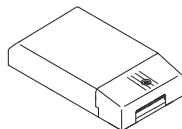

13 x 7,5 x 3 cm  8,5 cm **SELV** 

DRIVERS DIMMERABILI in corrente continua
DIMMABLE LED DRIVERS constant current**0129 Dimmer LED****Multipower dimmable driver**

IN: 110 - 240V
OUT: 700 mA, 1-4 Power LED

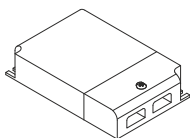



10,5 x 7 x 2,2 cm  7,2 cm **SELV** **PUSH** **1...10V**  

0129/DALI Dimmer LED**Multipower dimmable driver**

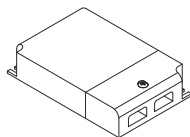
IN: 110 - 240V
OUT: 700 mA, 2-4 Power LED



10,5 x 7 x 2,2 cm  7,2 cm **SELV** **DALI**  

0141/DALI**LED driver**

IN: 110 - 240V
OUT: 700 mA, 1-2 Power LED

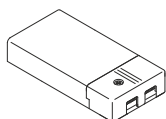

11,1 x 5,2 x 2,5 cm  5,5 cm **DALI**  

0141/DIM**LED driver**

IN: 110 - 240V
OUT: 700 mA, 1-2 Power LED

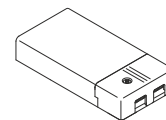

Versione PUSH non sincronizzabile - PUSH version not synchronizable

11,1 x 5,2 x 2,5 cm  5,5 cm **PUSH** **1...10V**  

0145 Dimmer LED Maxi**Multipower dimmable driver**

IN: 110 - 240V
OUT: 700 mA, 1-7 Power LED

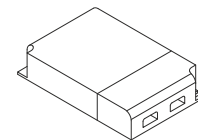

12,3 x 8 x 2,2 cm  8,4 cm **SELV** **PUSH** **1...10V**  

0145/DALI Dimmer LED Maxi**Multipower dimmable driver**

IN: 110 - 240V
OUT: 700 mA, 1-7 Power LED

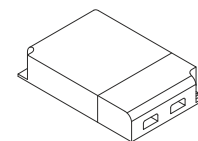

12,3 x 8 x 2,2 cm  8,4 cm **SELV** **DALI** **PUSH** **1...10V**  

0133

Cavo di sincronizzazione per dimmer LED
Synchronization cable for dimmer LED
(art. 0129 - art. 0129/DALI - art. 0145 - art. 0145/DALI)



L 150 cm

0726/DIM**LED dimmer**

TAGLIO DI FASE (IGBT-TRIAC, TRAILING EDGE-LEADING EDGE)
PHASE CUT-OFF (IGBT-TRIAC, TRAILING EDGE-LEADING EDGE)
IN: 220 - 240V
OUT: 24V - 20W
700 mA, 1-3 Power LED

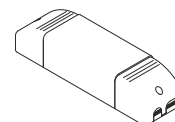

16,5 x 4,5 x 3,5 cm  5,6 cm **SELV** **PUSH** **IGBT-TRIAC** 



La presente scheda tecnica è di proprietà di EGOLUCE srl. Tutti i diritti sono riservati. Le fotografie, le descrizioni degli apparecchi, i disegni quotati ed i valori fotometrici menzionati sono a titolo indicativo e non costituiscono alcun impegno per la nostra società che si riserva di apportare, in qualsiasi momento e senza preavviso, tutte le modifiche che riterrà opportune.

EGOLUCE s.r.l., via I. Newton 12 - 20016 Pero - Milano
telefono +39 02 339586.1 - fax. +39 02 3535112
e-mail: info@egoluce.com - http://www.egoluce.com