

MINI CORNICHE FULL STAINLESS STEEL

8419111

MINI CORNICHE FULL STAINLESS STEEL 100 mm - LED
3000K 13°

Lighting information



Source power type	LED
Colour temperature	3000K
CRI	>80
MCADAMS	3
LM 80/TM-21	L80B10@>60Kh

Source power	3,00 W
Nominal flux	420 lm

Plug-in power	3,50 W
Real flux	250 lm
Maximum intensity	10500 cd/klm
Beam angle	13°

Power Supply Unit	24V
Operating frequency	DC
Dimmable	PWM
Safety class	III
Wiring	External
Cable section	2 x 0,50 mm ²
Cable length	5.000 mm;
Cable type	rubber+FEP
Connector	To be ordered separately

Protection Rating	IP68 Full Dry (2m)
Breaking Strength	IK 06

Energy efficiency class	A/A+/A++
Diffuser type	Serigraphed extra-clear glass
Diffuser thickness	5 mm



Platek®

PLATEK s.r.l.
Via Paderno, 19 | 25050 Rodengo Saiano (BS) ITALY
P.IVA 03320290178 | Codice fiscale 03007130176
Registro delle Imprese di Brescia n. 03007130176 REA 311057
Capitale sociale Euro 1.000.000,00 i.v. Società con unico socio

Last update:04/02/2022

MINI CORNICHE FULL STAINLESS STEEL

Product features

AISI 316 stainless steel body. No visible screws. Remote power supply with 24V DC constant-current transformer, to be wired in parallel. Before fixing the diffuser on the Platek products a Pre-treatment using an atmospheric pressure plasma process is carried out on the surface. The process activates the ionic load on the surface exactly where it is needed, thus promoting the best silicone grip possible and removing any residual release of agents for a longer lasting seal. The next steps are the coating of silicone and the assembly of the diffuser on the lighting fixture, with an automated process to guarantee the perfect sealing of the lamp. IP68 protection with Full Dry system which avoids condensation inside the product.

Technical dimensions

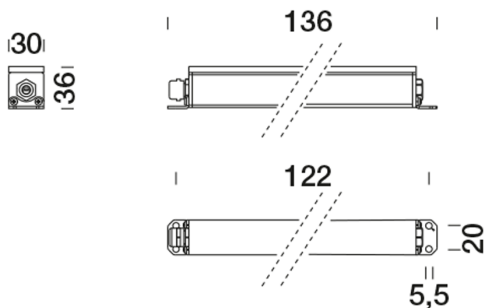

Technical shipping information

Net weight	0,70 kg
Gross weight	0,90 kg
Packaging width	170,00 mm
Packaging height	170,00 mm
Packaging depth	250,00 mm

8419111

MINI CORNICHE FULL STAINLESS STEEL 100 mm - LED 3000K 13°

Lighting information

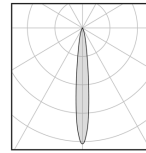

Plug-in power	3,50 W
Real flux	250 lm
Maximum intensity	10500 cd/klm
Beam angle	13°

Lighting Simulation



Spot beam angle

simulation made with MINI CORNICHE FULL STAINLESS STEEL 100 mm 3,5 W 3000K

Optics:	13°
Code:	8419111
Distance from wall:	0,10 m
Distance between products:	1,4 m
Wall height:	3 m

Plug-in power	3,50 W
Real flux	250 lm
Maximum intensity	10500 cd/klm
Beam angle	13°



MINI CORNICHE FULL STAINLESS STEEL

8419111

MINI CORNICHE FULL STAINLESS STEEL 100 mm - LED
3000K 13°

Electrical accessories

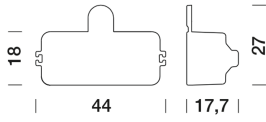

8917006
IP68 connector for 2x0,75 mm² cable

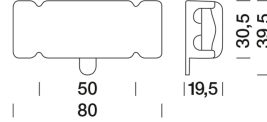

8917012
IP68 connector for 4x1,5 mm² cable

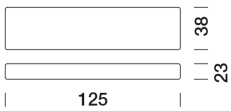

8956104
IP20 Power supply (24V DC - 30W)

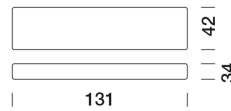

8956172
IP67 Power supply (24V DC - 30W)

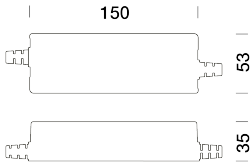

8956021
Power supply DALI (24V DC - 60W) IP67



MINI CORNICHE FULL STAINLESS STEEL

8419111

MINI CORNICHE FULL STAINLESS STEEL 100 mm - LED
3000K 13°

Full Inox

This material has high structural features that allow optimal combinations with other elements and great resistance to corrosion with little need for maintenance over time. Stainless steel is particularly suitable for exposure in aggressive environments, such as marine areas, cities with high pollution rates, chlorine-rich spaces and areas with elevated salt use during harsh Nordic winters.

Precise LED selection

All LEDS used by Platek, once assembled by trusted personnel are tested with suitable instruments to check the colour specification required by Platek standards. The choice of using only 3 McAdams colour steps and with a CRI value exceeding 90, provide a high level of light quality that is difficult to find in the world of outdoor lighting. As far as LED products are concerned, Platek has adopted a system of protection against electrostatic discharge along the entire production chain of electronic components to increase the resistance of circuits to power surges.

The gluing process and plasma treatment

One of the most complex and delicate aspects in outdoor lighting products is the fitting of glass onto the lighting body. This must ensure over time an excellent degree of insulation from atmospheric agents, even in harsh environmental conditions, to maintain a stable performance with zero maintenance. The gluing process of the glass on Platek products is managed at an automated workstation, preceded by a pre-treatment of the surfaces with atmospheric pressure plasma. Pre-treatment modifies the characteristics and ionic properties of the treated surfaces, activates the polar materials at strategic points, removes any residue of detaching agents, such as silicones and oils with a precision microcleaning, favouring excellent wettability of the bonded surfaces and a stable seal in time. The gluing process of the glass with specific plasma treatment allows a bonding force four times greater than similar products to be obtained. The shaping of the surfaces is followed by the application of the silicone and the assembly of the glass onto the lighting body using an automated process that guarantees perfect sealing of the lamp.

Platek®

PLATEK s.r.l.
Via Paderno, 19 | 25050 Rodengo Saiano (BS) ITALY
P.IVA 03320290178 | Codice fiscale 03007130176
Registro delle Imprese di Brescia n. 03007130176 REA 311057
Capitale sociale Euro 1.000.000,00 i.v. Società con unico socio

Last update:04/02/2022