



PICO FULL STAINLESS STEEL

8495011

PICO FULL STAINLESS STEEL - LED 3000K 20°

Lighting information

Source power type	LED
Colour temperature	3000K
CRI	>80
MCADAMS	3
LM 80/TM-21	L80B10@>60Kh
Photobiological safety	RG1 @0,7m

Source power	1,00 W
Nominal flux	140 lm

Plug-in power	1,30 W
Real flux	70 lm
Maximum intensity	5825 cd/klm
Beam angle	20°

Power Supply Unit	24V
Operating frequency	DC
Dimmable	Not dimmable
Safety class	III
Wiring	External
Cable section	2 x 0,50 mm ²
Cable length	5.000 mm;
Cable type	PCP rubber
Connector	To be ordered separately

Protection Rating	IP66/IP68 Full Dry (2m)
Breaking Strength	IK 07
Walk over	500 Kg

Energy efficiency class	A/A+/A++
Diffuser type	Transparent extra-clear glass
Diffuser thickness	2 mm

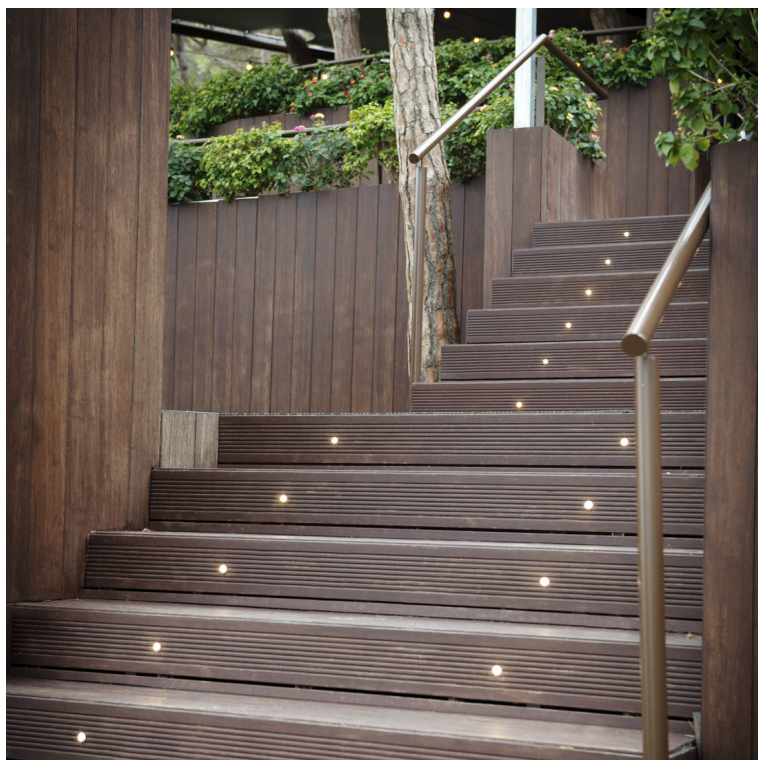

Platek®

PLATEK s.r.l.
Via Paderno, 19 | 25050 Rodengo Saiano (BS) ITALY
P.IVA 03320290178 | Codice fiscale 03007130176
Registro delle Imprese di Brescia n. 03007130176 REA 311057
Capitale sociale Euro 1.000.000,00 i.v. Società con unico socio

Last update:09/02/2022



PICO FULL STAINLESS STEEL

Product features

Body and front locking trim in AISI 316L stainless steel. IP68 Degree of protection with Full Dry system which avoids condensation inside the product. The Installation of the recessed housing in cast concrete with a 20-30 cm gravel soakaway. Only an IP68 connection to the power supply can guarantee the same protection to the fixture. Outer housing and connector to be ordered separately.

Technical dimensions

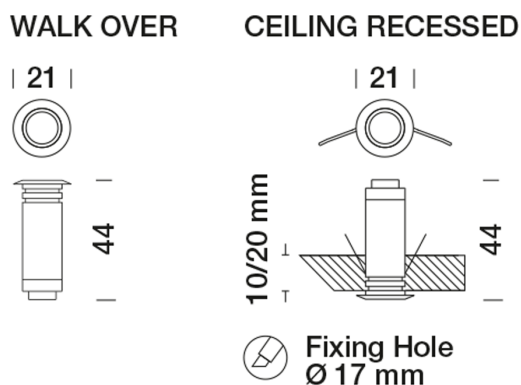

Technical shipping information

Net weight	0,80 kg
Gross weight	1,00 kg
Packaging width	50,00 mm
Packaging height	50,00 mm
Packaging depth	350,00 mm

8495011

PICO FULL STAINLESS STEEL - LED 3000K 20°

Lighting information

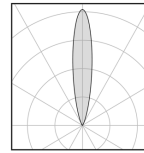

Plug-in power	1,30 W
Real flux	70 lm
Maximum intensity	5825 cd/klm
Beam angle	20°

Lighting Simulation

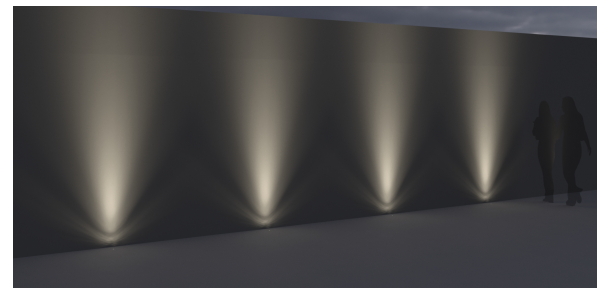

Spot beam angle

simulation made with PICO FULL STAINLESS STEEL 1,3 W 3000K

Optics:	20°
Code:	8495011
Distance from wall:	0,1 m
Distance between products:	2 m
Wall height:	3 m

Plug-in power	1,30 W
Real flux	70 lm
Maximum intensity	5825 cd/klm
Beam angle	20°



PICO FULL STAINLESS STEEL

8495011

PICO FULL STAINLESS STEEL - LED 3000K 20°

Mechanical accessories

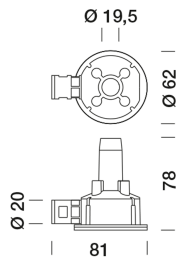

8945040
Recessed boxe Ø 62 mm H. 78 mm

Platek®

PLATEK s.r.l.
Via Paderno, 19 | 25050 Rodengo Saiano (BS) ITALY
P.IVA 03320290178 | Codice fiscale 03007130176
Registro delle Imprese di Brescia n. 03007130176 REA 311057
Capitale sociale Euro 1.000.000,00 i.v. Società con unico socio

Last update:09/02/2022



PICO FULL STAINLESS STEEL

8495011

PICO FULL STAINLESS STEEL - LED 3000K 20°

Electrical accessories

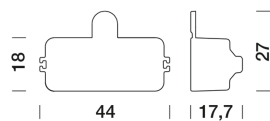

8917006
IP68 connector for 2x0,75 mm² cable

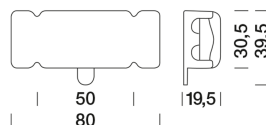

8917012
IP68 connector for 4x1,5 mm² cable

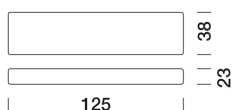

8956104
IP20 Power supply (24V DC - 30W)

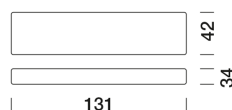

8956172
IP67 Power supply (24V DC - 30W)

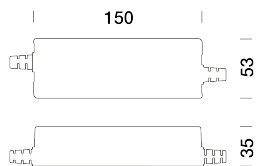

8956021
Power supply DALI (24V DC - 60W) IP67



PICO FULL STAINLESS STEEL

8495011

PICO FULL STAINLESS STEEL - LED 3000K 20°

Full Inox

This material has high structural features that allow optimal combinations with other elements and great resistance to corrosion with little need for maintenance over time. Stainless steel is particularly suitable for exposure in aggressive environments, such as marine areas, cities with high pollution rates, chlorine-rich spaces and areas with elevated salt use during harsh Nordic winters.

Precise LED selection

All LEDS used by Platek, once assembled by trusted personnel are tested with suitable instruments to check the colour specification required by Platek standards. The choice of using only 3 McAdams colour steps and with a CRI value exceeding 90, provide a high level of light quality that is difficult to find in the world of outdoor lighting. As far as LED products are concerned, Platek has adopted a system of protection against electrostatic discharge along the entire production chain of electronic components to increase the resistance of circuits to power surges.

Platek®

PLATEK s.r.l.
Via Paderno, 19 | 25050 Rodengo Saiano (BS) ITALY
P.IVA 03320290178 | Codice fiscale 03007130176
Registro delle Imprese di Brescia n. 03007130176 REA 311057
Capitale sociale Euro 1.000.000,00 i.v. Società con unico socio

Last update:09/02/2022